

NINA1 WITH I-TANK INSULATED BOWL AND ELECTRONIC CONTROL



**Ref: 562010
(NINA1)**

NINA 1 STD 230/50 WHITE WITH INSULATED BOWL - GAS R134A

General Features

NINA 1 INSULATED is a mini dispenser that prepares cold creams, sherbets and slush.

Compact and lightweight, NINA 1 thanks to the 2 litres bowl and its small size, is a compelling proposal for locations with low volume requirements, for the operators who have limited space and low sales volumes and for off-season use when the frozen products demand is low.

This equipment has I-TANK™ insulated bowl as standard; the insulated bowl I-Tank minimizes the influence of external temperature, increases the cooling power of the machine, saving energy and money, and reduces condensation on the bowl's outer side, thus improving the product's aesthetics.

The tank has a capacity of 2 litres, to reduce waste and to provide high product rotation and freshness.

The front electronic keypad can be used to set the temperature and the defrost mode.

This mini slush machine has a special fire-resistant plastic frame composed of ABS & Polycarbonate, and steel side panels.

NINA 1 is cutting-edge, easy to use, very attractive and exclusive.

NINA1 WITH I-TANK INSULATED BOWL AND ELECTRONIC CONTROL

Specifications

- Mini dispenser that prepares cold creams, sherbets and slushies.
- Well-suited for operators with limited space and low sales volumes, or can be particularly useful during the off-season when demand for frozen products is low.
- The small size of the tank allows for more frequent renewal of the product inside, ensuring greater freshness.
- Safety stop system.
- It is possible to customize the graphics on the front and on the back (subject to negotiation)

Construction

- Small footprint.
- This equipment has a special fire-resistant plastic frame composed of ABS & Polycarbonate, and steel side panels.
- The patented I-Tank insulated bowl reduces the impact of ambient temperature on the product, improving its cooling efficiency and guaranteeing energy and cost savings.
- n. 1 insulated tank containing 2 litres of finished product.

NINA1 WITH I-TANK INSULATED BOWL AND ELECTRONIC CONTROL

Electric

Supply voltage:	220-240 V / 1 ph / 50 Hz
Electrical power max.:	0.23 kW
Current consumption:	1.7 Amps
Plug type:	CE-SCHUKO

Key Information:

Number of bowls:	1
Bowl's capacity:	2 lt
Control board:	Electronic
Dimensions, Width:	160 mm
Dimensions, Depth:	385 mm
Dimensions, Height:	473 mm
Net weight:	15 kg
Cooling system:	AIR

Refrigeration Data

Refrigerant gas:	R134a
------------------	-------

Certifications



The company reserves the right to make modifications to the products without prior notice. All information correct at time of printing.

2024.12.06

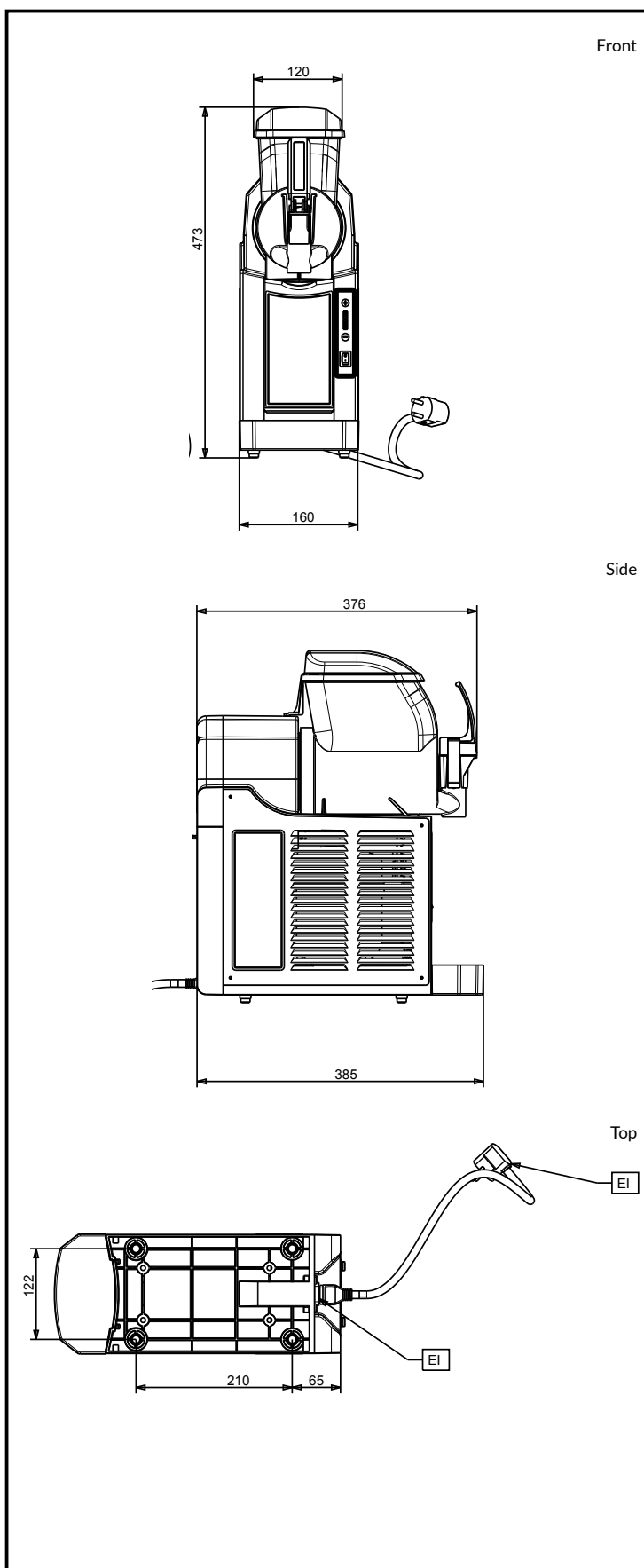

SPM

www.spm.drink-systems.com
infospm@electroluxprofessional.com